

HAYWARD®

Installation, Operation & Service Procedures Pool and Spa/Hot Tub Heaters

Models C-SPA-XI 55 & C-SPA-XI 11

parts4heating
800-536-1582 Fax: 866-448-9304
info@parts4heating.com

C-SPA-XI
conforms to
UL 1261 for
outdoor or
indoor use.



Underwriters
Laboratories Inc.®

LOCAL CODES:

Your spa heater must be installed as shown in these installation instructions as well as to adhere to all local codes and electric utility requirements.

WARNING:

If you do not follow these instructions exactly, a fire or explosion may result with property damage, personal injury or loss of life.

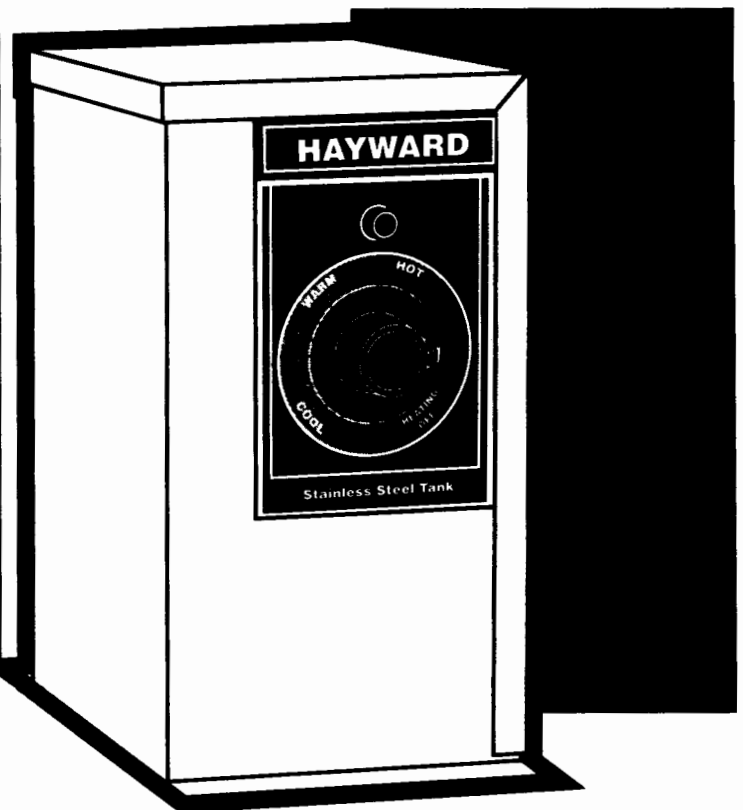

HAYWARD®

Installation, Operation & Service Procedures Pool and Spa/Hot Tub Heaters

Models C-SPA-XI 55 & C-SPA-XI 11

C-SPA-XI

conforms to
UL 1261 for
outdoor or
indoor use.



Underwriters
Laboratories Inc.®

LOCAL CODES:

Your spa heater must be installed as shown in these installation instructions as well as to adhere to all local codes and electric utility requirements.

WARNING:

If you do not follow these instructions exactly, a fire or explosion may result with property damage, personal injury or loss of life.

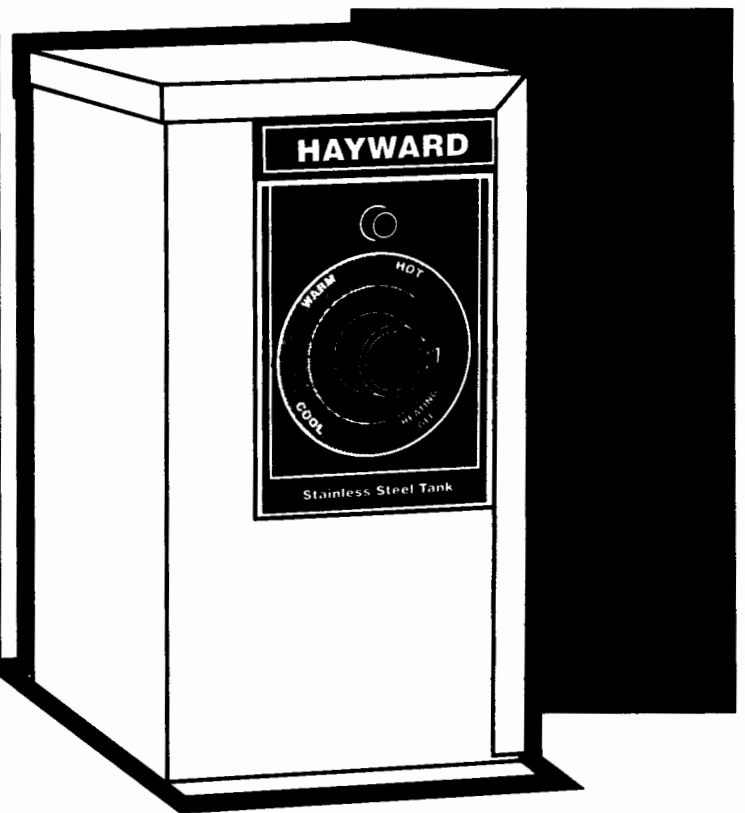

Table of Contents

	PAGE
Information	2
Warranty	2
Specifications & Dimensions	3
Water Piping	3
Electrical	3
Wiring Diagrams	4
Startup	4
Operation	4
Factory Pressure Switch	5
Above Spa Surface Installation	5
Below Spa Surface Installation	5
Maintenance & Adjustment	6
If Heater Does Not Heat	6
Parts List	7
Parts Drawing of Heater	7

Limited warranty summary:

We warrant your spa heater to be free from defects in materials and workmanship, and we will, within two years from date of installation, for the original purchaser, repair or, at our option, replace without charge any defective part. Cost of freight, installation, electricity and service labor at user's expense.

If your spa heater is damaged or destroyed by improper maintenance, excessive water hardness or incorrect water chemistry or freezing, it is not covered under the manufacturer's warranty. For full details of warranty agreement, see warranty certificates shipped with heater.

IMPORTANT SAFETY INSTRUCTIONS:

When using this electrical equipment, basic safety precautions should always be followed, including the following:

1. READ AND FOLLOW ALL INSTRUCTIONS.
2. To reduce the risk of injury:
 - A. Do not ingest alcohol or drugs during or prior to using your spa or hot tub. Ingestion of such intoxicants may cause drowsiness which can lead to unconsciousness, and subsequently result in drowning.
 - B. The water in a spa or hot tub should never exceed 104°F (40°C). A maximum water temperature in excess of 104°F is not considered safe for all persons. Lower water temperatures are recommended for extended use (exceeding 10-15 minutes) and for young children. Hotter water increases the risk of hyperthermia. (See description below).

- C. Pregnant women beware! Soaking in water above 102°F (39°C) can cause fetal damage during first three months of pregnancy (resulting in the birth of a brain-damaged or deformed child). Pregnant women should adhere to the 100°F (38°C) maximum rule.
- D. Before entering the spa or hot tub, users should check the water temperature with an accurate thermometer at several occupant locations; spa or hot tub thermostats may err in regulating water temperatures by as much as ±5°F (±3°C).
- E. Persons suffering from obesity with medical history of heart disease, circulatory problems, diabetes or blood pressure problems should obtain their physician's advice before using spas or hot tubs.
- F. Persons using medication should consult a physician before using a spa or hot tub since some medication may induce drowsiness while other medication may affect heart rate, blood pressure and circulation.
- G. If the spa is used for therapy, it should be done with the advice of a physician. Always stir spa water before entering the spa to mix in any hot surface layer of water that might exceed healthful temperature limits and cause injury.
- H. Do not tamper with controls, because scald can result if safety controls are not in proper order.

3. SAVE THESE INSTRUCTIONS.

Hyperthermia:

The causes, symptoms, and effects of hyperthermia may be described as follows: Hyperthermia occurs when the internal pressure of the body reaches a level several degrees above the normal body temperature of 98.6°F. The symptoms of hyperthermia include dizziness, fainting, drowsiness, lethargy, and an increase in the internal temperature of the body. The effects of hyperthermia include; (1) unawareness of impending hazard, (2) failure to perceive heat, (3) failure to recognize the need to exit spa or hot tub, (4) fetal damage in pregnant women, and (6) unconsciousness resulting in a danger of drowning.

▲WARNING: The use of alcohol, drugs or medication can greatly increase the risk of fatal hyperthermia in spas and hot tubs.

Facts about water chemistry:

FACTORS which affect spa water and, more importantly, the efficiency and operation of your spa heater.

1. PROPER FILTRATION
2. PROPER CIRCULATION
3. DISINFECTION AND OXIDATION
4. pH CONTROL AND TOTAL ALKALINITY
5. ALGAE CONTROL

pH is the measure of the acidity or alkalinity of water. As shown on this chart, it is a critical measurement.

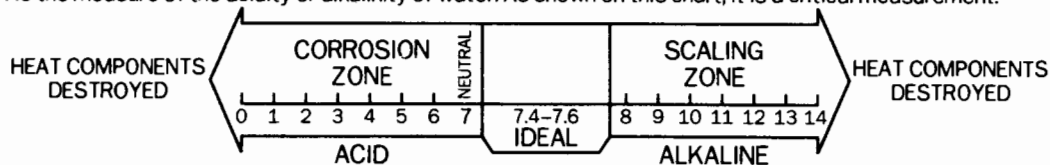

We recommend using a four way test kit to obtain...

1. CORRECT pH (7.2-7.8)
2. CHLORINE RESIDUAL (1.0-5.0 PPM)
3. TOTAL ALKALINITY (80-120 PPM)
4. CALCIUM HARDNESS

▲NOTE: CALCIUM HARDNESS SHOULD BE 175-350 PPM depending on spa finish.

Figure 1

Installation, start-up and operating instructions for your electric spa heater

Specifications and Dimensions:

Figure 2

MODEL	B.T.U.	KW	AMP RATINGS 240 VOLT	WIRE SIZE* 240 VOLT	GROUND WIRE SIZE*	BREAKER SIZE* 240 VOLT	GPH 20° RISE	GPH 40° RISE	WATER CONN.	SHIP WT.
C-SPA-XI 5.5	18,766	5.5	23	10	10	30	120	56	1 1/2"	14
C-SPA-XI 11	37,532	11	46	6	10	60	225	112	1 1/2"	14

*PER NEC-LOCAL CODES APPLY-COPPER ONLY.
WIRE SIZE APPLIES TO RUNS UP TO 50 FEET.
FOR EACH ADDITIONAL 50 FOOT RUN, SELECT WIRE SIZE ONE GAUGE LARGER.

Installer please note:

1. Inspect for concealed damage upon receipt. Advise shipper of damage. File any damage claims with delivering carrier.
2. Spa heater must be installed according to instructions or manufacturer's warranty is void.
3. Your electric spa heater can be located anywhere in an outdoor or indoor location with a minimum clearance of six (6) inches to all combustible construction. Maintain adequate access clearance for servicing heater. Locate your heater in such a way that should the tank or any of its connections leak, the water will not damage anything. Under no circumstances will we, the manufacturer, be held liable for water damage in connection with your heater. The heater should be connected in the return line from the filter to the spa. Water shut off valves must not be installed in the piping from the outlet of the spa heater to the spa. Blocking the return pipe in any fashion can create a hazardous condition.

Water piping:

These heaters are designed for use with spa/hot tub water only, as furnished by municipal water distribution systems. The warranty does not cover its use with mineral water, sea, salt or other non-potable waters.

*Minimum piping to be used is 1 1/2" I.D. (interior dimension). No valve or restriction is to be installed in line between heater outlet and spa unless the heater is below spa level. In that case, a swing check valve that does not include a shut-off feature or function should be installed to prevent back flow. No hartford loop is required.

Optional CPVC use:

CPVC piping may be used on both inlet and outlet threaded heater connections.

Typical piping diagram:

* No water shut off valves are to be installed between the heater outlet and the return to the spa/tub.

Figure 3

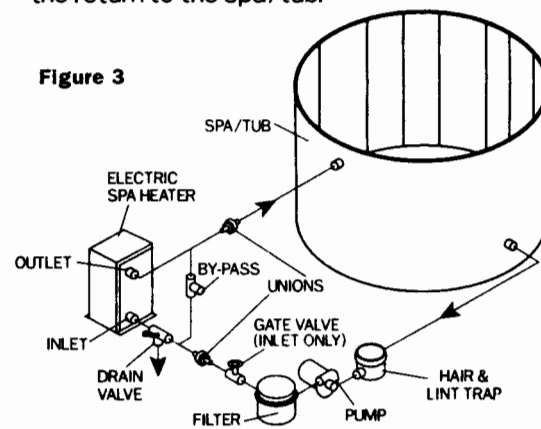

A G.E. silicone seal or similar sealant with a high elasticity must be used to compensate for temperature expansion and contraction of the dissimilar materials at the water connections, otherwise leakage will occur.

Electrical connections:

Before any electrical connections are made, be sure that the heater is full of water and that any valve in the cold water supply line is open.

Check the rating plate and wiring diagram before proceeding.

▲NOTE: Customer to furnish disconnect switch. Wire in accordance with attached wiring diagrams.

Field wiring, power supply conductors and branch circuit protectors must be installed by a qualified electrician in accordance with Article 680 of the National Electrical Code ANS/NFPA No. 70-

C-SPA-XI Wiring: Observe correct wiring size between job site breaker and junction box in heater.

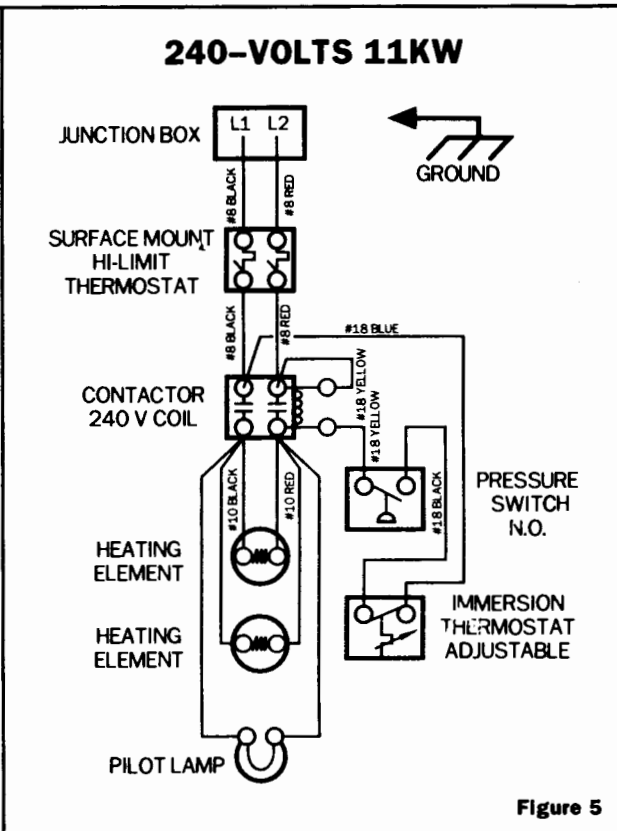
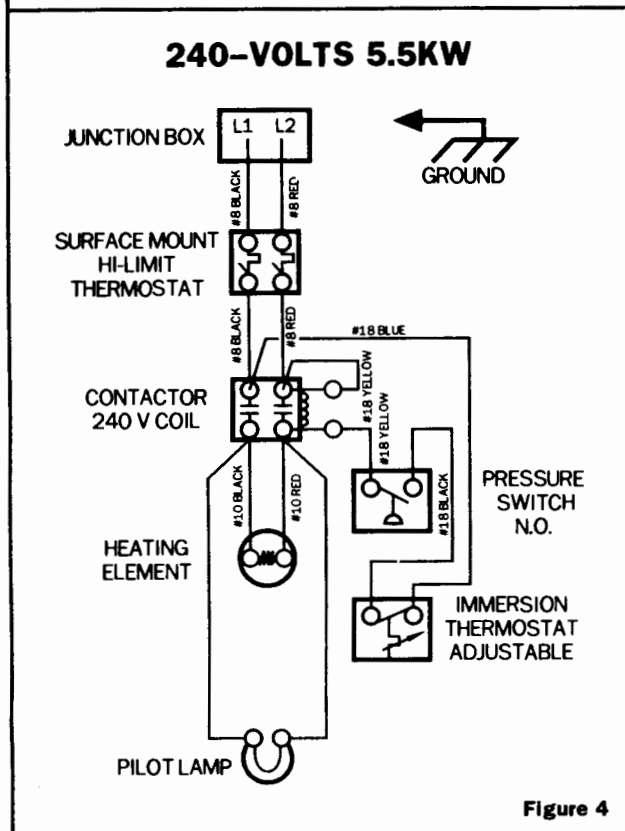

(latest edition) and in accordance with local codes and/or electric utility requirements. It is recommended that the heater supply circuit be protected by a ground-fault circuit-interrupter (GFCI) in accordance with Article 680-5(b) of the National Electrical Code.

A wire connector marked, "GROUND" is provided within the control box. To reduce the risk of electrical shock, connect this terminal or connector to the grounding terminal of the electrical service or supply panel with a continuous green insulated copper wire equivalent in size as specified for Ground Wire Size on Figure 2. Grounding must be in accordance with Article 250 of the National Electrical Code. A bonding wire must be connected to the bonding lug on the heater exterior right side Refer to Article 250 Part G. for bonding requirements of the National Electrical Code. Be sure all connections are clean and secure.

Startup:

1. Clean filter. Start filter pump. **Make sure all air is out of the spa plumbing lines.** Wait five minutes.
2. Close electrical disconnect switch.
3. Set C-SPA-XI thermostat at desired temperature. Disconnect time clock during initial heat-up. Your outlet temperature will feel just slightly warmer than the inlet temperature. Do not be concerned; this is normal.

Operation:

The adjustable external thermostat on your C-SPA-XI heater has a "positive off" provision at the lowest temperature setting. Movement of the thermostat knob to this position will prevent operation of the heater.

CAUTION: Internal components of the heater are still "live" electrically even with the thermostat turned off. The main breaker or disconnect for this unit must be turned off before servicing the unit. The spa temperature may be adjusted by turning the thermostat knob up or down until the spa temperature reaches the desired level. Adjustments should be made in small increments and sufficient time should be allowed for the body of water to heat or cool before further adjustments are made. When the exact desired comfort level is reached, you may wish to lock the thermostat dial lock at this position by tightening the dial lock screw.

The pilot lamp on your C-SPA-XI is an indicator that the element(s) should be operating. It will cycle on and off with the thermostat.

WARNING: Spa temperature is to be determined by an accurate spa thermometer. "Test" the water temperature with your hand before entering the spa. See "Warning" on page 2.

Factory installed pressure switch:

The function of the pressure switch is to shut the spa heater off if the pump is turned off or if the

Figure 6

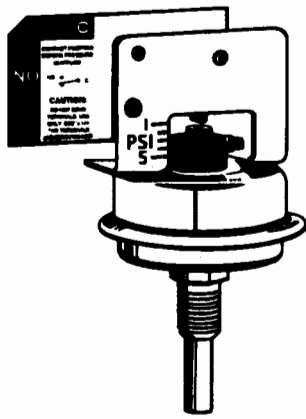

filter gets so dirty that it restricts the flow of the water to the heater. Do not adjust the switch unless the heater is installed more than two (2) feet below surface of spa water. If adjustment is necessary, follow the procedure as outlined. Refer to the diagrams for approximate settings for various heights.

Your heater is equipped with a pressure switch that is adjustable from one to five pounds. The switch is factory set at 3 psi \pm 3/4 psi.

Installation below spa surface:

CAUTION: Do not remove any access covers from the C-SPA-XI until all sources of electrical power to the unit have been turned off or disconnected. Do not make any repairs or pressure switch adjustments with the power on.

1. Clean filter thoroughly.
2. Set heater thermostat to highest setting.
3. Start filter pump. Make sure all air is out of water lines and complete system is full of water.

4. Turn filter pump and power source off, adjust pressure switch control. Signal light on heater will indicate off when power is restored. See caution above.
5. Check pressure switch function by turning filter pump on and off causing heater to respond on or off. If heater is installed beyond pressure limits, a flow switch must be installed in water line to heater.

Installation above spa surface:

1. If heater is installed less than three (3) feet above the surface of the spa water, install eyeball fittings or directional flow fittings on the end of the return water line to the spa to create adequate back pressure at the heater to operate the pressure safety switch when filter pump is running.
2. If heater is installed more than three (3) feet above surface of spa water, install as shown above to prevent drainage of water in heater during filter change.

WARNING: No valves or other obstructions are to be installed between the heater outlet and the return to the spa. See water piping on page 3.

Two speed pump:

In some cases, the pressure from a two speed pump is below the one pound minimum required to operate the heater. This is apparent when the pressure switch cannot be further adjusted. In these cases the pump must be run at high speed to operate heater. If your pump and piping arrangements are such that the required one pound minimum pressure cannot be obtained, do not attempt to operate the heater. Correct the installation.

Installation Below Pool Surface
Figure 7

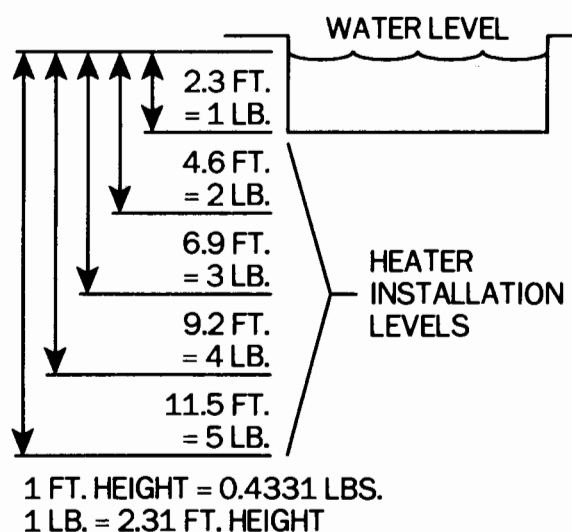

Installation Above Pool Surface.
Figure 8

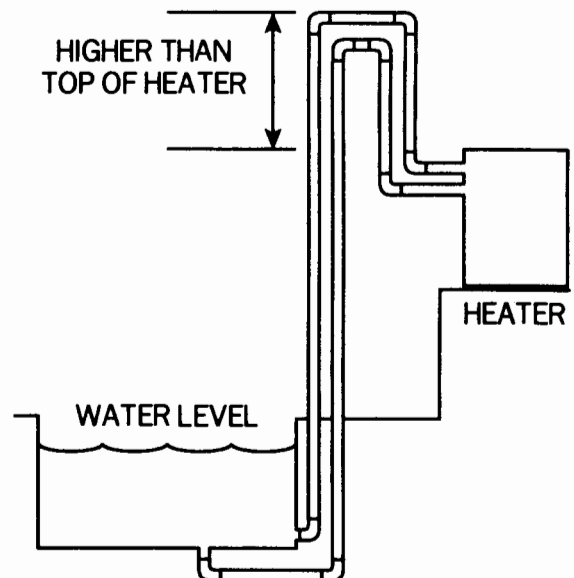

Maintenance and adjustment

Dry-firing of elements:

Caused by water voids when power is on. **All air must be purged from system before any heater start-up. It is especially important to purge all air after cleaning or changing a cartridge filter.** Since the filter casement acts as an air reservoir during this procedure, the circulation system must be on for at least five minutes to purge and bleed all air from the system before turning on power to the heater. A dry-fired element (soft annealed or blistered and/or completely burned off) is not a warranty failure.

If heater does not heat:

1. Check filter for pressure and cleanliness.
2. Turn pump on.
3. Turn the heater thermostat to the highest position.
4. If the indicator light does not come on, check the following:
 - A. Push reset button on side of heater.
 - B. Check breaker in fuse panel box.
 - C. If the reset button is engaged and the main breaker in fuse panel okay, contact your installing dealer, factory authorized service center or Hayward Pool Products, Inc.
5. If the Indicator light comes on but you have no heating, contact your installing dealer, factory authorized service center or Hayward Pool Products, Inc.

Use of chlorinators and chemical feeders:

▲WARNING: Chlorinators and feeders that are misadjusted may cause severe and rapid corrosion to the heater heat exchanger. This damage is not covered under the manufacturer's warranty.

Chemicals must be completely diluted into the pool/spa water before circulation through the heater. Check the following conditions.

- A. Chlorine tablets or bromine sticks should not be placed in the skimmer.
- B. Do not use non-stable chemicals.
- C. Chlorinator must be installed downstream from heater, have a check valve to prevent chemical back-up, or be wired in such a manner that chlorinator shuts off with the filter pump.
- D. Tether "floaters" such that they will not be drawn to the skimmer.

Contactors failures or chattering contactors:

Principally caused by dirty filters and by marginal water flow conditions. Filters must be back-

washed and the water flow must be maintained as per manufacturer's installation instructions.

In addition, contactor failures may be caused by undersized field wiring creating a high electrical resistance, and low voltage. Contactor failures under these conditions are not warranty problems.

Lack of, or insufficient cleaning and back-washing filter skimmer baskets can result in contactor failure. This is not covered under the certificate of warranty.

Winterization/Freezing:

If your heater is to be shut off and exposed to freezing temperature, it must be drained. Water, when frozen, will expand, damaging your tank. Shut off or disconnect your electrical supply to the heater before draining. Follow the startup instructions before you restore your electrical supply. Freeze damage is not covered by the limited warranty.

Chemical vapors:

Spa maintenance chemicals may produce vapors harmful to your C-SPA-XI. Never store chemicals or any flammables near your spa heater. Destruction of the heater by corrosion or a fire can result.

High limit:

In case of overheating, your C-SPA-XI heater will shut itself off. This is accomplished by the use of a manual reset high limit. To place the heater back in operation, reset the limit per the label instructions on the heater. If the high limit trips again, turn the main heater breaker off and contact your installing dealer, factory authorized service center or Hayward Pool Products, Inc.

Water flow:

Your C-SPA-XI must have an adequate flow of water for proper operation. (See installation and start up procedures.) Adequate water flow removes the heat produced by the heater, transfers the heat to the spa and prevents overheating. Low water flow usually results from a dirty filter or improperly adjusted manual by-pass. Manual by-pass valves should be set so that the outlet thermometer reads 6-8°F above the spa water after five (5) minutes of heater operation.

The recommended minimum flow through the heater is 12 GPM (gallons per minute) up to a maximum flow of 60 GPM. If flow exceeds 60 GPM, refer to figure 3 and install external by-pass.

Parts Illustration

Order repair parts by item number and part description with the model and serial number of the heater. The model and serial number will be found on the data plate, item no. 26.

Figure 9

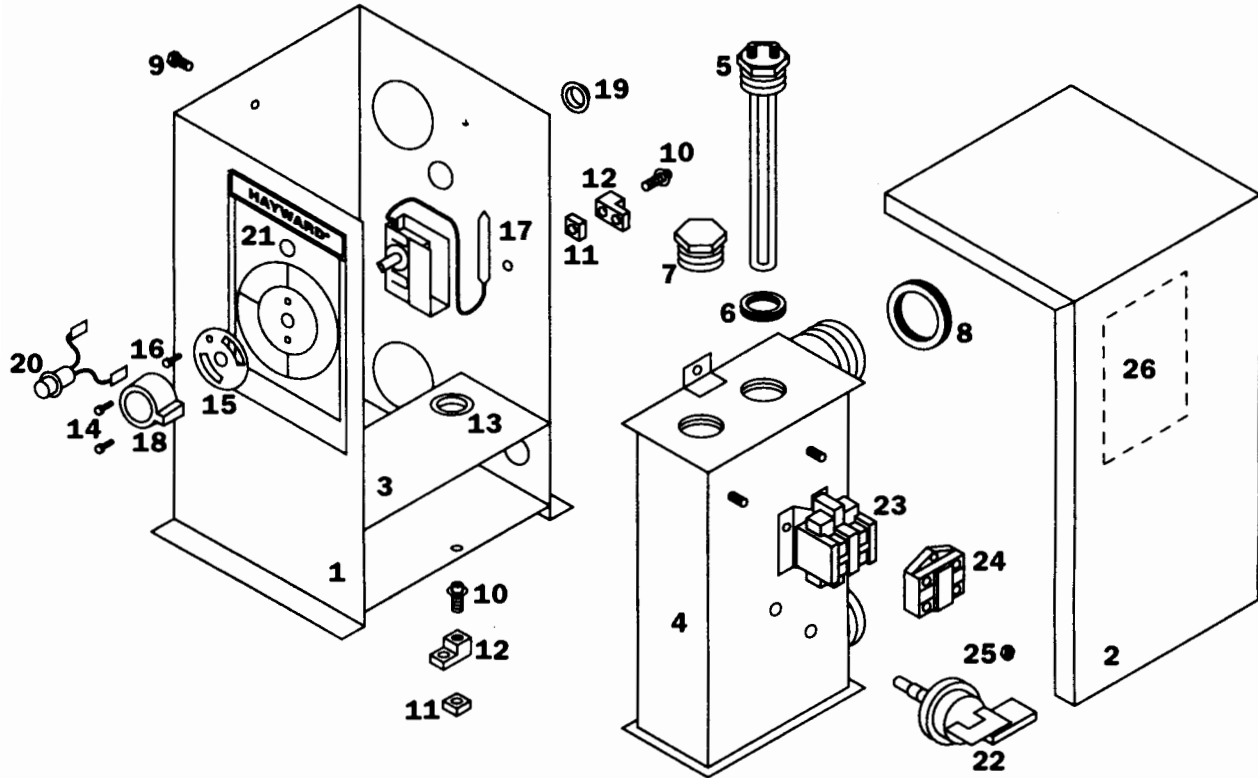

ELEMENT CHART	
MODEL	NO. ELEMENTS
C-SPA-XI 5.5	1-5.5 KW
C-SPA-XI 11	2-5.5 KW

C-SPA-XI parts list

ITEM NO.	DESCRIPTION	PART NO.	ITEM NO.	DESCRIPTION	PART NO.
1.	Jacket Assembly	CZX JKT 7500	22.	Pressure Switch	CZX PRS 1105
2.	Jacket Cover	CZX JKT 7003	23.	Contactor	CZX CON 3645
3.	Junction Box	CZX JBX 7402	24.	High Limit	CZX HLC 3105
4.	Tank	CZX TNK 6607	25.	High Limit and Contactor Nut	CZX NUT 6404
5.	Element-Wattage 5500, Voltage 240	CZX ELE 7623	†26.	Data Plate	CZX DAP 7265
6.	Element Gasket	CZX GKT 7627	NOT SHOWN		
7.	Element Hole Plug w/Gasket	CZX ELP 7622		Reset Label	CZX LBL 8400
8.	Inlet Outlet Gasket	CZX GKT 9216		Wiring Diagram Label	CZX LBL 7264
9.	Tek Screw	CZX SCR 6101		Inlet Label	CZX LBL 7700
10.	Ground Lug Bolt	CZX BLT 5411		Outlet Label	CZX LBL 7701
11.	Ground Lug Nut	CZX NUT 5403		Caution Power Label	CZX LBL 5600
12.	Ground Lug	CZX GRL 2900		Fill Warning Label	CZX LBL 5100
13.	Heyco Bushing	CZX HYB 1702		#8 Wire Red 7" w/Ring Terminals	CZX WIR 8602
14.	Thermostat Screw	CZX SCR 3003		#8 Wire Black 7" w/Ring Terminals	CZX WIR 8702
15.	Thermostat Dial Lock	CZX TDL 0102		#8 Wire Red 16"-1 Ring Terminal	CZX WIR 8603
16.	Dial Lock Screw	CZX SCR 2102		#8 Wire Black 16"-1 Ring Terminal	CZX WIR 8703
17.	Thermostat	CZX TST 3006		#18 Wire Red 7"-Solid	CZX WIR 5002
18.	Thermostat Knob	CZX TJK 2003		#10 Wire Black 7"-Solid	CZX WIR 6613
19.	Grommet, High Limit	CZX GRM 9209		#14 Wire Black 8" w/Quick Conn. Ends	CZX WIR 5801
20.	Indicator Light -240v	CZX LIT 3613		#14 Wire Blue 5" w/Quick Conn. Ends	CZX WIR 6601
21.	Thermostat Label w/Logo	CZX LBL 7257		† Replaced upon return of damaged plate.	

parts  heating
800-536-1582 Fax: 866-448-9304
info@parts4heating.com



HAYWARD POOL PRODUCTS, INC.

Hayward Pool Products, Inc.
900 Fairmount Avenue
Elizabeth, NJ 07207

Hayward Pool Products, Inc.
2875 Pomona Boulevard
Pomona, CA 91768

Hayward Pool Products Canada
2880 Plymouth Drive
Oakville, Ontario L6H 5R4

Hayward S.A.
Zoning de Jumet
B6040 Jumet, Belgium