

G67 Intermittent Pilot Ignition Controls

parts4heating
800-536-1582 Fax: 866-448-9304
info@parts4heating.com



Figure 1: G67 Intermittent Pilot Ignition Control

Description

The G67 Intermittent Pilot Ignition Control is used to automatically light a pilot burner and energize the main burner gas valve of a heating system in response to the thermostat's call for heat. When the heating load is satisfied, the thermostat opens and the G67 de-energizes the pilot and main burner gas valves. The G67 can be used with equipment with a maximum firing rate of 117 kW (400,000 Btu/hr). Any application over 117 kW (400,000 Btu/hr) must be approved in advance by the Johnson Controls Application Engineering Department.

All G67 applications must use redundant gas valves. Consideration must be given to the temperature of the surface on which the G67 is mounted. These controls are suitable for operation over a temperature range of -40 to 66°C (-40 to 150°F).

Table 1: Specifications

Ignition Type	Indirect
Ignition Source	High voltage spark, capacitive discharge
Maximum High Voltage Cable Length	1,220 mm (48 in.) recommended
Flame Detection Means	Flame rectification
Flame Detection Types	Remote sensing
Minimum Flame Current	0.2 microampere
Flame Failure Response Time	0.8 second, maximum
Spark Gap	2.5 mm (0.1 in.), nominal
Ignition Trial Times	Infinite
Power Requirements	Control: 24 VAC, 50/60 Hz, nominal Operation Current: 0.15A nominal + valves
Contact Rating	Main Valve: 2A continuous, 5A inrush Pilot Valve: 2A continuous, 5A inrush
Ambient Operating and Storage Temperature	-40 to 66°C (-40 to 150°F)
Humidity	95% RH non-condensing
Types of Gas	Natural (Liquefied Petroleum (LP), manufactured, mixed, or LP gas-air mixture may be used in a well vented or outdoor application)
Packaging	Bulk pack supplied to original equipment manufacturer (individual pack optional).
Bulk Pack Quantity	50
Bulk Pack Weight	12 kg (27 lb)
Agency Listing	IAS (AGA/CGA) Certificate Number C2154020
Specification Standards	ANSI Standard Z21.20 CSA C22.2-No. 199

The performance specifications are nominal and conform to acceptable industry standards. For application at conditions beyond these specifications, consult the local Johnson Controls office. Johnson Controls, Inc. shall not be liable for damages resulting from misapplication or misuse of its products.

**Operating Mode
Definitions**

The following definitions describe operating conditions:

Trial for Ignition--Period during which the pilot valve and spark are activated attempting to ignite gas at the main burner.

Run--Main gas valve remains energized and spark is turned off after successful ignition.

Flameout--Loss of proven flame. Should a flameout occur, the main valve closes and the spark recurs within 0.8 seconds.

Application

The G67 ignition control may only be used for two types of applications:

- well ventilated or outdoor application
- power vent or induced draft application

Use the G67B() only on rooftop, excess air, and power vented gas burning equipment.

When using the G67, the appliance or equipment must be approved by a recognized testing agency in accordance with the applicable American National Standards. See *Table 1: Specifications*. No other application is permissible.

The G67 solid-state ignition control lights a pilot burner by a spark. Pilot gas is ignited and burns during each run cycle (intermittent pilot). Main burner and pilot gas are extinguished during the Off cycle.

The main gas valve will not open until the pilot flame has been proven by the sensing circuit. Should a loss of flame occur, the main valve closes and the spark recurs within 0.8 seconds.

Sequence of Operation

Figure 2 illustrates the sequence of operation for the G67 control.

On a call for heat from the system thermostat, the G67 ignition control simultaneously opens the pilot valve and supplies a continuous spark to the pilot burner's electrode. When the pilot burner gas ignites, the pilot flame sensor detects the pilot flame and signals the G67 to energize the main gas valve and discontinue the spark. The main gas valve will not be energized until the flame sensor detects the presence of the pilot flame.

If the pilot flame goes out (with the thermostat still calling for heat), the G67 will de-energize the main gas valve and provide a continuous spark at the pilot burner's electrode. When the pilot flame is re-ignited and detected by the pilot flame sensor, the main gas valve is energized and the spark is shut off. The G67 ignition control de-energizes the pilot gas valve and main burner gas valve when the thermostat stops calling for heat.

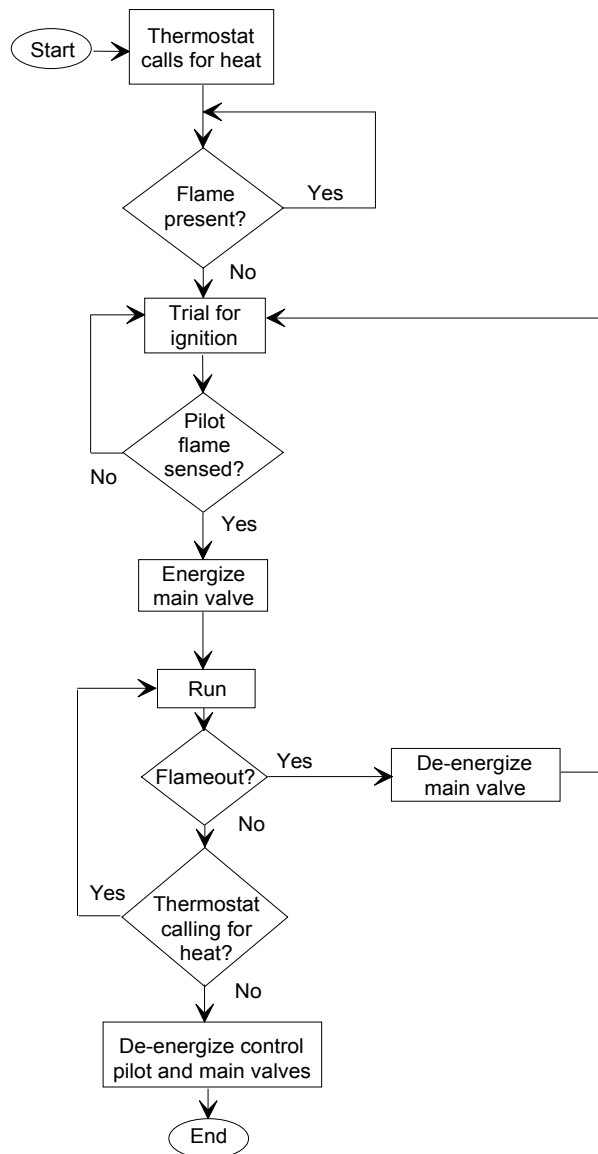



Figure 2: Sequence of Operation

Installation and Wiring

IMPORTANT: These instructions are intended as a guide for qualified personnel installing or servicing Johnson Controls ignition controls. Carefully follow all instructions in this sheet and all instructions on the appliance. Limit repairs, adjustments, and servicing to the operations listed in this sheet or on the appliance.

 **WARNING:** **Fire or Explosion Hazard.** Avoid serious injury by carefully following precautions in this sheet and all instructions on the appliance. Limit repairs, adjustments, and servicing to the operations listed in this sheet or on the appliance.

 **WARNING:** **Fire or Explosion Hazard.** If the control is installed in an area that is exposed to water (dripping, spraying, rain, etc.), it must be protected. If the control has been exposed to water in any way, do not use it.

Ignition Control

 **WARNING:** **Shock Hazard.** Avoid electrical shock and equipment damage. Disconnect electrical power and turn off gas before wiring control.

Location/Mounting

Choose a location that provides the shortest, direct cable route to the spark electrode, flame sensor assembly. Easy access to the terminals is desired for wiring and servicing. The G67 may be mounted in any position. Mount the control on a grounded metal surface with No. 8 machine or No. 6 sheet metal screws.

 **CAUTION:** **Equipment Damage Hazard.** Do not mount the control where it will be exposed to direct infrared radiation from the main burner or to temperatures in excess of the maximum product temperature rating.

To mount the G67 ignition control:

1. Attach the flame sensor securely to the pilot burner. The tip of the sensor is intended for direct exposure to the flame.
2. Connect the sensor lead to the flame sensor and to Terminal 4 on the G67.
3. Attach the high voltage cable from the pilot burner electrode to the ignition transformer on the G67.
4. Install the terminal boot to cover the exposed ignition transformer terminal.

Electrical Connections

 **CAUTION: Equipment Damage Hazard.** Connect the high voltage cable to the spark transformer terminal and spark electrode (pilot burner assembly) before applying power to the control. Ensure the ground wire is attached to the pilot burner and control ground terminal strip.

 **CAUTION: Equipment Damage Hazard.** Locate all limit and operating controls in series with the thermostat terminal (THS 2) on the ignition control.

Refer to Figures 3, 4, and 5 for wiring schematic and wiring diagrams. All wiring should be in accordance with the National Electrical Code (NEC) and all other local codes and regulations. The high voltage spark transformer cable must not be in continuous contact with a metal surface. Use standoff insulators. Ensure that the flame sensor wire and the high voltage spark transformer cable are separated from one another by a minimum distance of 6.35 mm (1/4 in.) and are not wrapped around any pipe, other wiring, or accessories.

Check the voltage rating marked on the control and make sure it is suited to the application. Use an NEC Class 2 transformer to provide 24 VAC under maximum load, including valves. A transformer having excessive primary impedance due to poor coupling will affect the ignition potential.

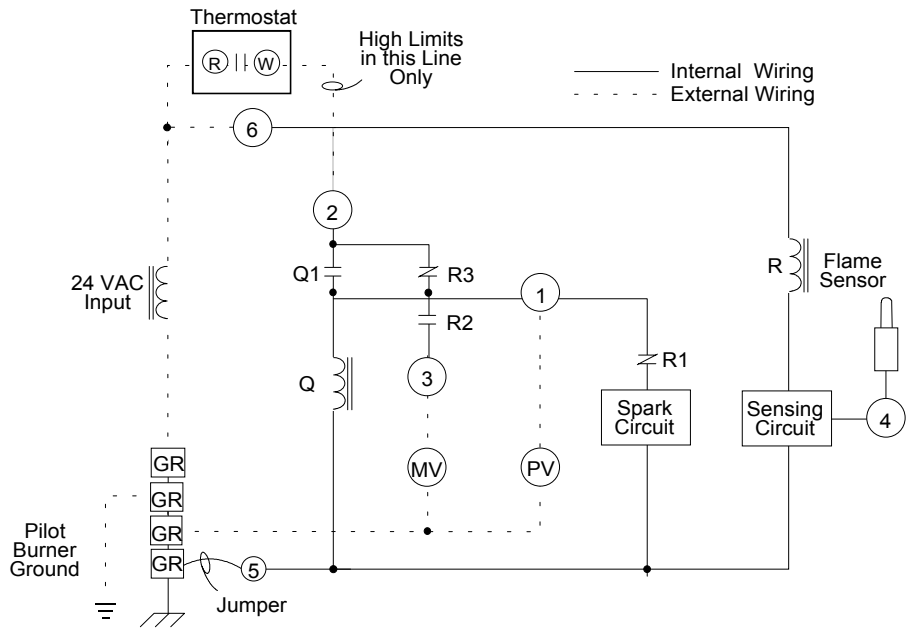
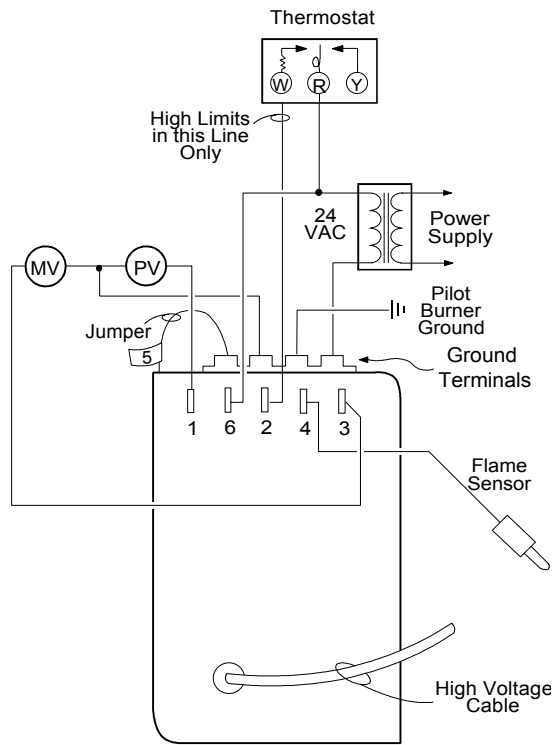
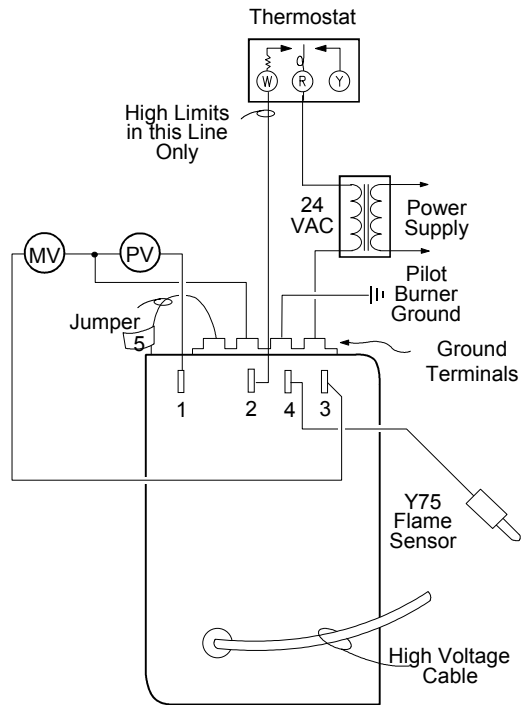

Figure 3: Wiring Schematic for G67 Self-Checking Control



Power is wired directly to R (Common) on the thermostat and Terminal 6 on the G67.

Figure 4: Wiring Diagram for G67A()



Power is wired directly to R (Common) on the thermostat. Terminals 1 and 2 on the G67 are tied together internally.

Figure 5: Wiring Diagram for G67B()

Checkout and Startup Procedure

WARNING: **Fire or Explosion Hazard.** Avoid personal injury or property damage by making sure the control functions properly and there are no gas leaks. Follow this checkout and startup procedure before leaving the installation.

WARNING: **Fire or Explosion Hazard.** Do not attempt to check out this system by manually lighting the pilot. This could energize the main valve.

Make sure all components function properly by performing the following shutoff test.

1. Temporarily disconnect the flame sensor by removing the sensor cable from Terminal 4 on the G67.
2. With power off and gas on, purge gas lines of all air. Using a soap solution, check for positive gas seal at the valve inlet and on all upstream pipe connections.
3. Close the main manual shutoff valve and wait 5 minutes. Then turn the valve to the On position.

4. Turn on power to the appliance and turn the thermostat to a high setting.

Note: If the system is power vented, the vent motor should operate. The G67 initiates sparking at the pilot burner/spark igniter and opens the pilot valve. Pilot burner gas ignites; main burner must not ignite.

5. Turn down the thermostat for 30 seconds (to reset the system), then turn it up again.
6. Disconnect the main valve lead from Terminal 3 on the G67. Connect a DC microammeter in series with the flame sensor lead and Terminal 4 on the control (observe correct polarity). The DC current should be 0.2 microampere or greater. If it is less, see the *Service Checkout Procedures* section.
7. Turn down the thermostat, disconnect the microammeter, and reconnect the main valve lead and the sensor lead.
8. Turn up the thermostat. The G67 initiates sparking at the pilot burner/spark igniter and opens the pilot valve. After the pilot gas ignites, the flame sensor detects the presence of pilot flame and the control energizes the main valve and de-energizes the spark.
9. Turn down the thermostat. The main gas and pilot flame should extinguish. Verify successful ignition at least three times before leaving the installation.

**Thermostat
Heat Anticipator
Settings**

The anticipator setting is normally equal to the ignition system current draw, plus that of the pilot and main valve.

Due to variations in appliance wiring and valves, it is advisable to measure the actual current draw of the heating system at the thermostat location. Measuring this current can be accomplished by opening the thermostat contacts (lowering the set point) and installing an AC ammeter across the terminals, or by using a clamp-on ammeter with a 10-turn multiplier attached to the terminals. See Figure 6.

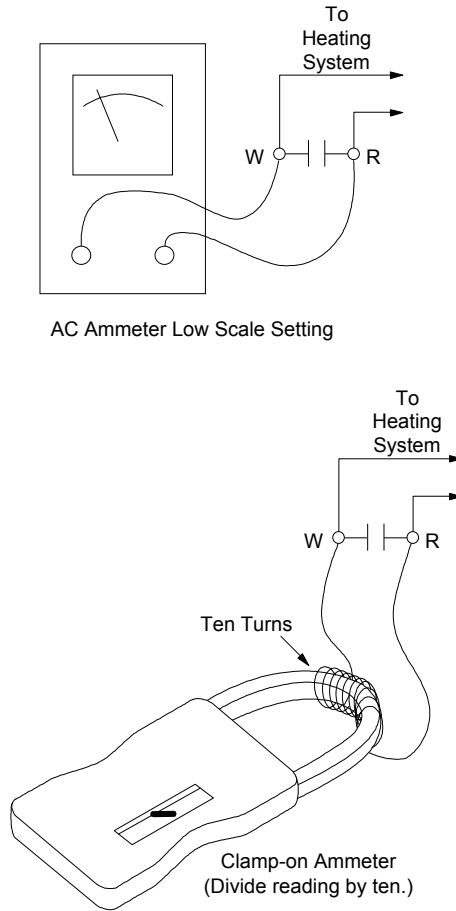

Figure 6: Measuring the Thermostat Current

**Service
Checkout
Procedures**

If the system does not function properly, determine the cause using the procedures in this section.

**Preliminary
Checks**

Before proceeding with troubleshooting the system, check the following:

- Are all mechanical and electrical connections tight?
- Is the system wired correctly?
- Is gas inlet pressure per manufacturer's specifications?
- Is the system powered?
- Is the thermostat calling for heat?

**Failure
Conditions and
Corrective Action**

There are three potential system failure conditions:

- no spark, and system does not work
- spark present, but pilot does not light
- pilot lights, but main valve does not come on

Determine the failure condition, then use the respective flowchart on the following pages to troubleshoot the system. Perform the procedures in the *Checkout and Startup Procedure* section after any servicing.

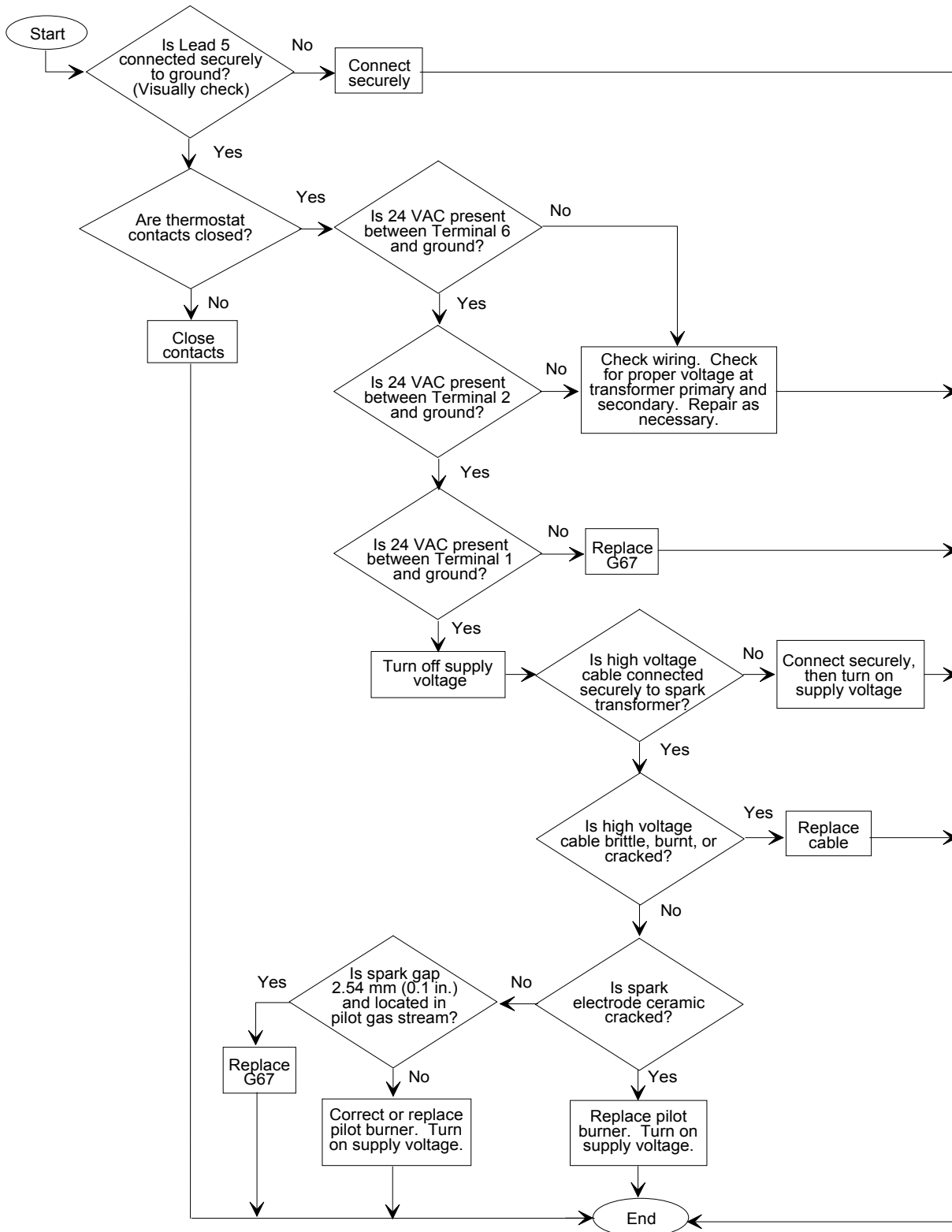

Figure 7: No Spark, and System Does Not Work

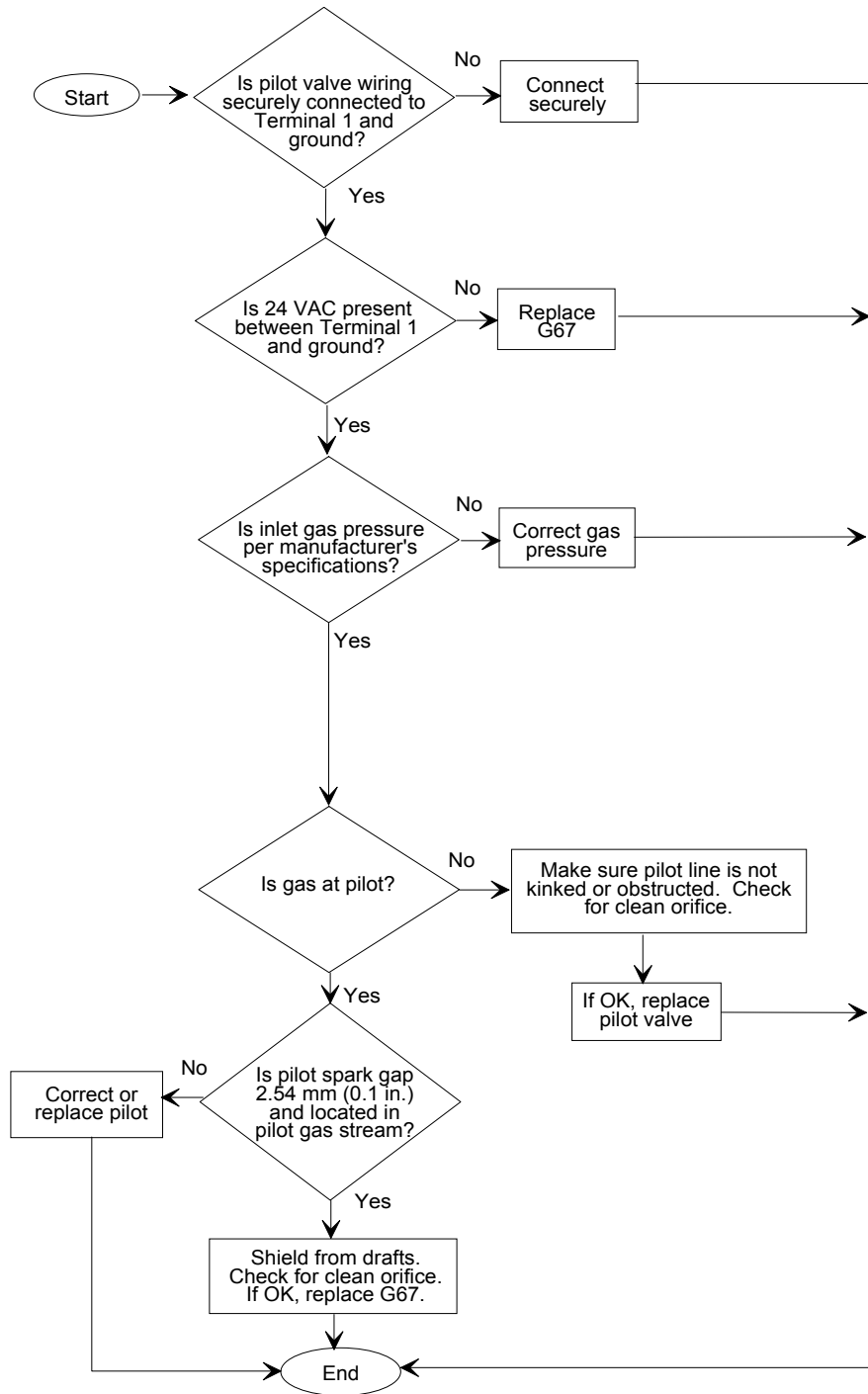

Figure 8: Spark Present, but Pilot Does Not Light

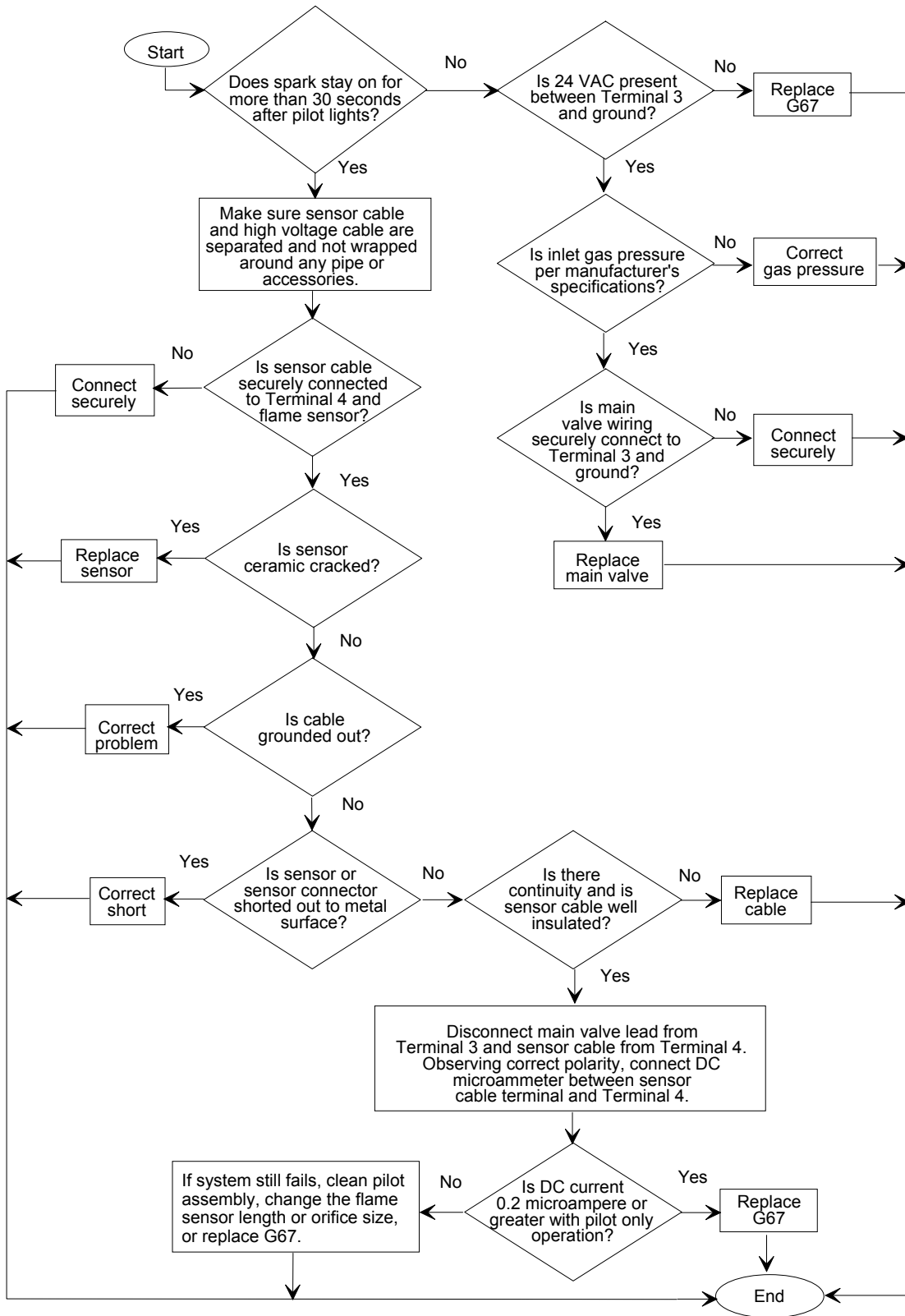

Figure 9: Pilot Lights, but Main Valve Does Not Come On

***Repairs and
Replacement***



CAUTION: Label all wires prior to disconnection when servicing controls. Wiring errors can cause improper and dangerous operation.

The G67 control is not field repairable. **Do not** attempt field repairs. Use only an exact or factory-recommended replacement control.

All other accessories, such as flame sensors, electrode assemblies, pilot assemblies, and leads can be obtained through the original equipment manufacturer or Johnson Controls distributor.

Notes



JOHNSON
CONTROLS

Controls Group
507 E. Michigan Street
P.O. Box 423
Milwaukee, WI 53201

www.johnsoncontrols.com
FAN 121
Installation Sheets Manual
Printed in U.S.A.